

T-UTG - Uchwyty T z trzpieniem gwintowanym

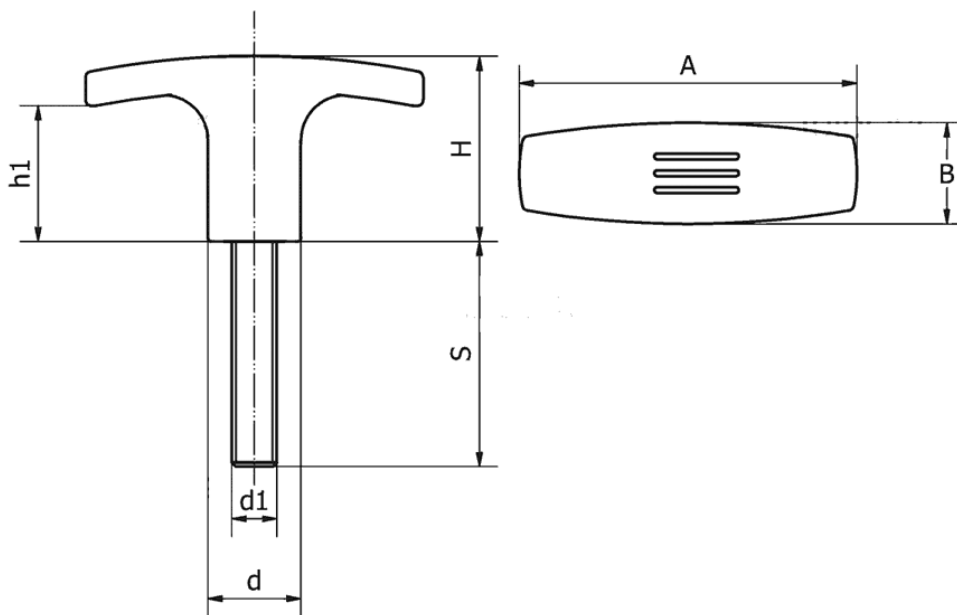

Dane techniczne:

- **Materiał: PA**
- **Kolor: czarny (RAL 9005)**

Symbol	A	B	H	h1	d	Gwint zewn. d1	Długość gwintu zewn. S	Materiał	Kolor
	[mm]	[mm]	[mm]	[mm]	[mm]		[mm]		
T-UTG-72-M12x50	72	19	34	20	18	M12	50	PA	czarny