

NGSE/PGSE/SNGSE/SPGSE - Osłona krawędzi

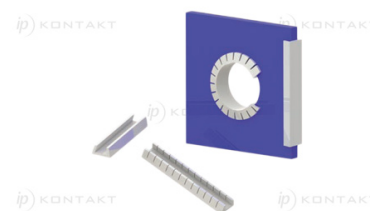
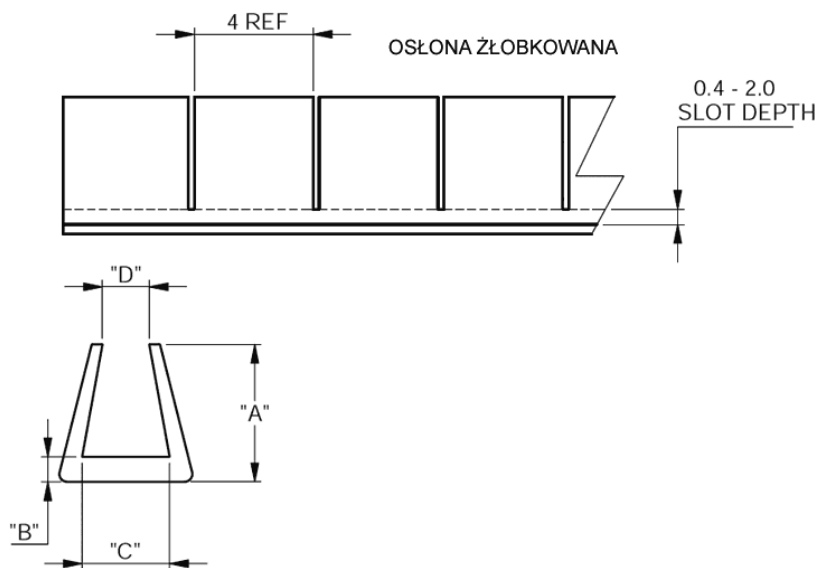

Dane techniczne:

- **Materiał: Nylon RMS-413***
- **Materiał: Polyethylene RMS-412***
- **Kolor: naturalny**
- **Minimum zakupu: Rolka 30 metrów**
- **Typ 1 - pełny**
- **Typ 2 - żłobkowany**

Symbol	Typ	Zakres grubości panelu	A	B	C	D	Materiał	Kolor
		[mm]	[mm]	[mm]	[mm]	[mm]		
SPGSE-5	2	4.8 - 6.4	4.8	1.2	6.4	4.8	LDPE	naturalny