

O-OKPVC2 - Osłony krawędzi z PVC



Typ 1



Typ 2





Typ 3



Typ 4



Typ 5



Typ 6



Typ 7



Typ 8

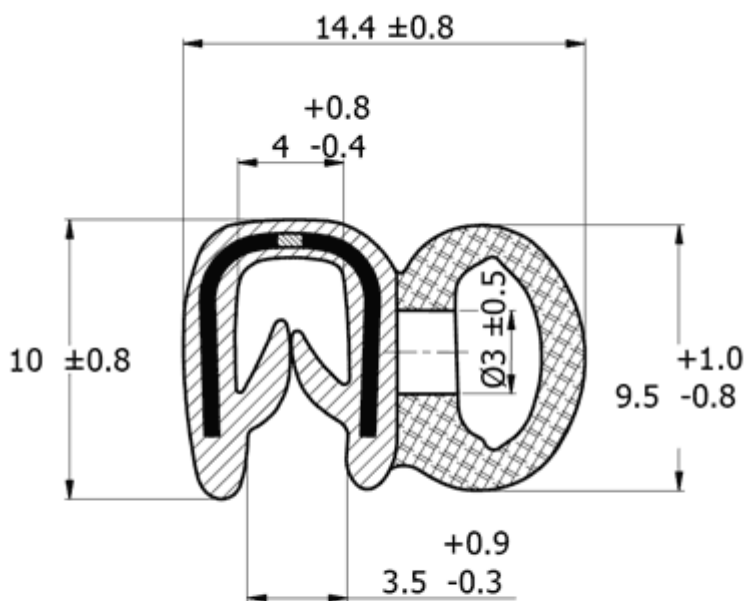

Typ 9

Dane techniczne:

- **Materiał:** PVC z rdzeniami stalowymi
- **Kolor:** czarny (BLK), szary (GR), biel tytanowa (WH)
- **Dostarczany w rolkach po 20m**
- **Profile są elastyczne - możliwy montaż ręczny**
- **Zakres temperatur:** -40°C do +90°C

Symbol	Typ	Zakres grubości panelu	Materiał	Kolor	Opakowanie
		[mm]			[m]
O-OKPVC2-04-WH	4	1 - 3	PVC	biały	20