

O-KNU - Nakrętki radełkowe

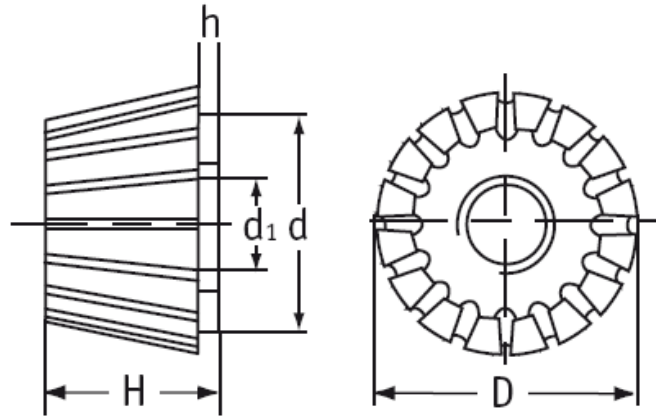

Typ 1

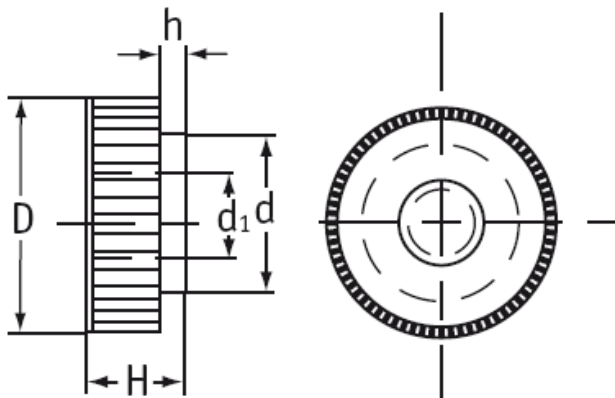
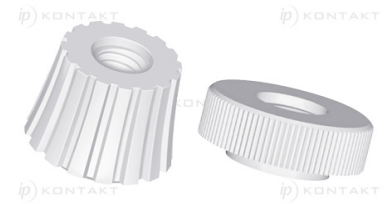

Typ 2

Dane techniczne:

- **Material:** Nylon 6.6
- **Kolor:** Naturalny
- Typ 1: stożkowa
- Typ 2: standardowa
- Opakowanie: 1000 szt.

Symbol	Typ	Gwint d	D	d ₁	Wysokość H	h	Materiał	Kolor
			[mm]	[mm]	[mm]	[mm]		
O-KNU-2-M5-20-35	2	M5	20	10	8	3.5	PA 66	naturalny