

## O-KNU - Nakrętki radełkowe

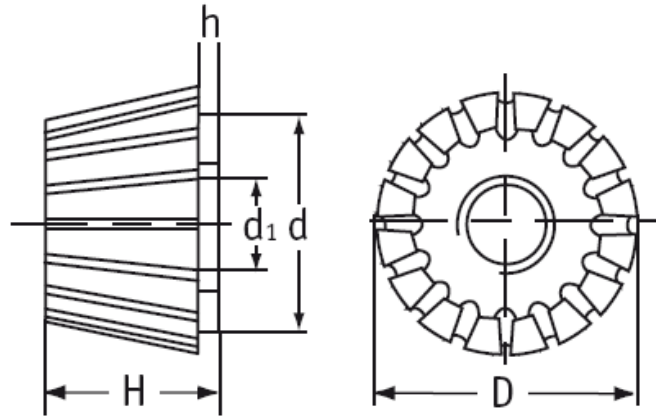

Typ 1

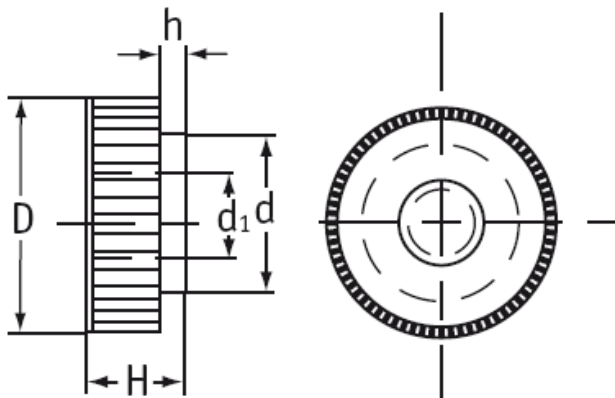
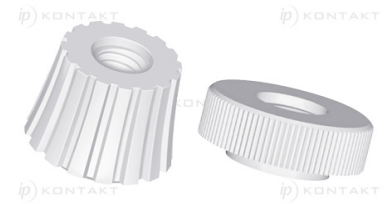

Typ 2

**Dane techniczne:**

- **Material:** Nylon 6.6
- **Kolor:** Naturalny
- Typ 1: stożkowa
- Typ 2: standardowa
- Opakowanie: 1000 szt.

Symbol	Typ	Gwint d	D	d <sub>1</sub>	Wysokość H	h	Materiał	Kolor
			[mm]	[mm]	[mm]	[mm]		
O-KNU-1-M8	1	M8	16	14	12	1	PA 66	naturalny