

## NGSE/PGSE/SNGSE/SPGSE - Osłona krawędzi

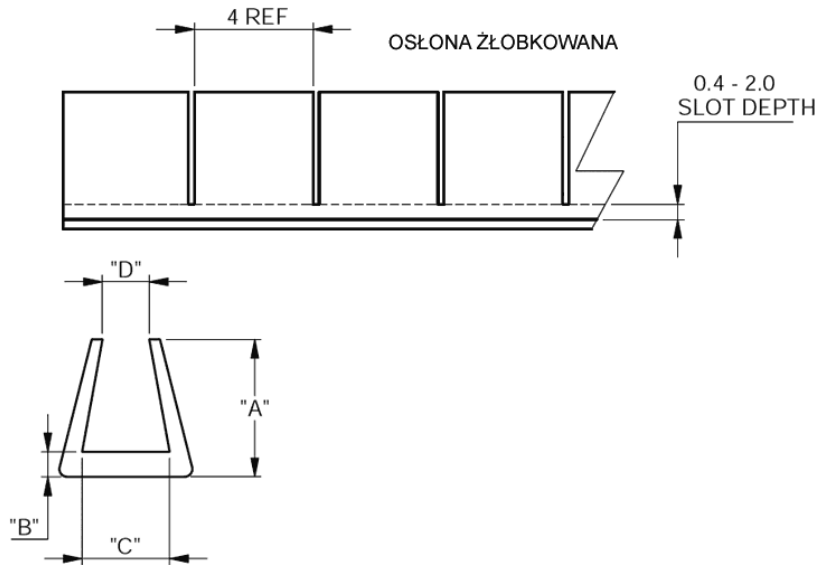

### Dane techniczne:

- **Materiał: Nylon RMS-413\***
- **Materiał: Polyethylene RMS-412\***
- **Kolor: naturalny**
- **Minimum zakupu: Rolka 30 metrów**
- **Typ 1 - pełny**
- **Typ 2 - żłobkowany**

Symbol	Typ	Zakres grubości panelu	A	B	C	D	Materiał	Kolor
		[mm]	[mm]	[mm]	[mm]	[mm]		
NGSE-5	1	4.8 - 6.4	2.8	1.2	6.4	4.8	PA 6	naturalny