

MNI - Tulejki izolacyjne z kołnierzem

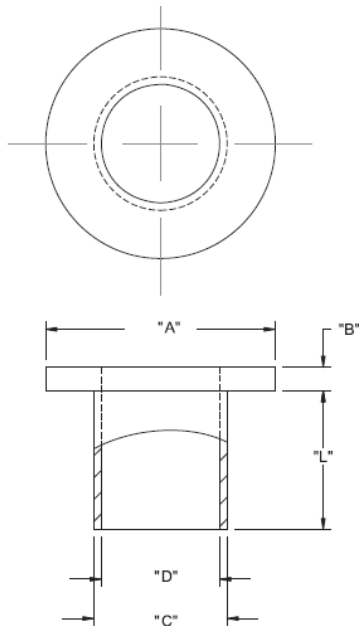

Dane techniczne:

- **Nylon 6/6, UL 94 V-2, RMS-01 ***
- **Nylon 6/6, UL 94 V-2, RMS-48 ***
- **Kolor:** naturalny - NAT
- Minimum zakupu: 1000 szt.

Symbol	Gwint	A ±0.18	B ±0.18	C ±0.13	D ±0.13	Długość L ±0.13	RMS	Materiał
		[mm]	[mm]	[mm]	[mm]	[mm]		
MNI#8-4	M4	8.7	1.6	5.2	4.4	1.6	RMS-48	PA 66