

LEDS2M - Podstawka / wspornik pod LED

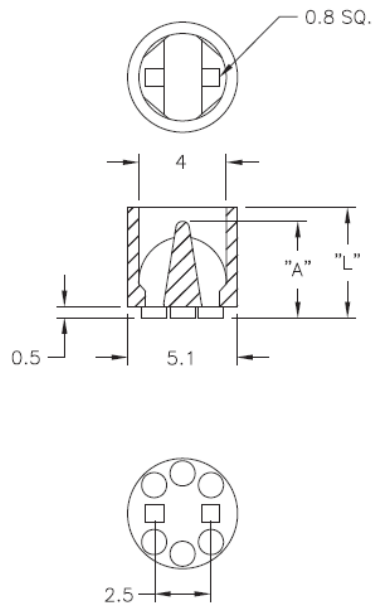

Dane techniczne:

- **Nylon 6/6, UL 94 V-2, RMS-01 ***
- **Kolor:** naturalny
- Minimum zakupu: 1000 szt.

Symbol	Typ LED	Wysokość L ±0.25	A	Materiał	Klasa palności	Kolor
		[mm]	[mm]			
LEDS2M-180-01	T-1 3/4	4.6	2	PA 66	UL94 V-2	naturalny