

LEDM - Podstawka / wspornik pod LED

LEDM-1 For T-1 3/4 Series LED

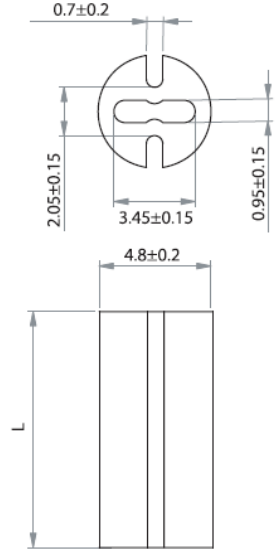

LEDM-2 For T-1 Series LED



LEDM-3 For T-1 3/4 Series LED

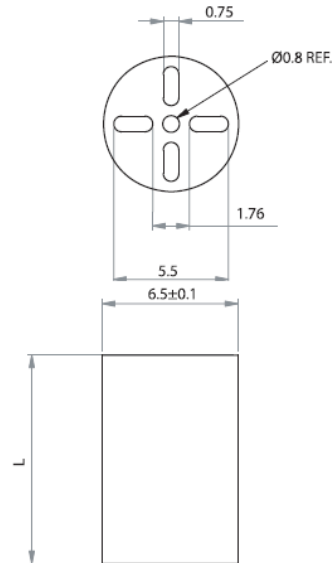

Dane techniczne:

- **Materiał:** PVC, UL94 V0, RMS-388*
- **Kolor:** czarny
- Minimum zakupu: 1000 szt.

Symbol	Wysokość L	Typ	Materiał	Klasa palności	Kolor
	[mm]				
LEDM-3-24	24	LEDM-3	PVC	UL94 V-0	czarny