

H-PR - Nity plastikowe

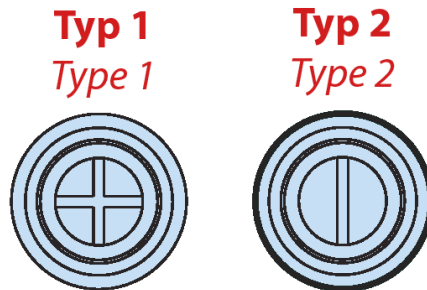
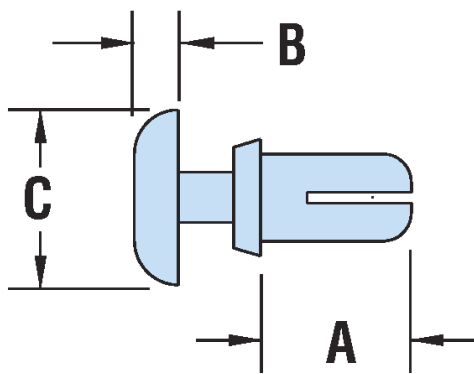

Dane techniczne:

- **Materiał:** Nylon 6 UL94 V-2 lub Nylon 6/6 UL94 V-0
- **Kolor:** biały lub czarny
- **Zakres temperatur:** -40°C do 115°C

Symbol	Średnica otworu montażowego	Zakres grubości panelu	A	B	C	Siła ekstrakcji	Typ	Materiał	Klasa palności	Kolor
	[mm]	[mm]	[mm]	[mm]	[mm]	[daN]				
H-9310	2.6	4.3 - 5.3	6.4	1.5	5.1	4.9	2	PA 6	UL94 V-2	czarny