

H-PR - Nity plastikowe

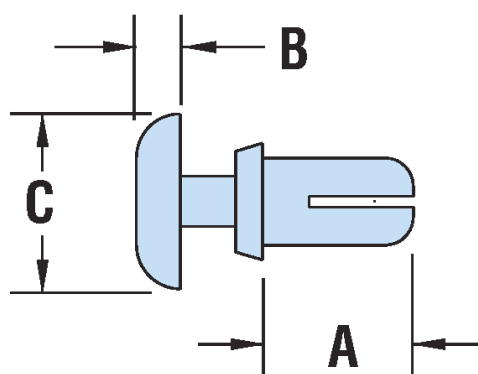

Typ 1
Type 1

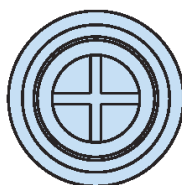

Typ 2
Type 2

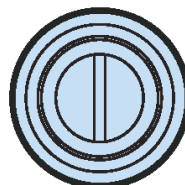

Dane techniczne:

- **Materiał:** Nylon 6 UL94 V-2 lub Nylon 6/6 UL94 V-0
- **Kolor:** biały lub czarny
- **Zakres temperatur:** -40°C do 115°C

Symbol	Średnica otworu montażowego	Zakres grubości panelu	A	B	C	Siła ekstrakcji	Typ	Materiał	Klasa palności	Kolor
	[mm]	[mm]	[mm]	[mm]	[mm]	[daN]				
H-9046	3.6	2.0 - 3.0	4.6	1.5	6.4	11.8	1	PA 6	UL94 V-2	czarny