

H-PR - Nity plastikowe

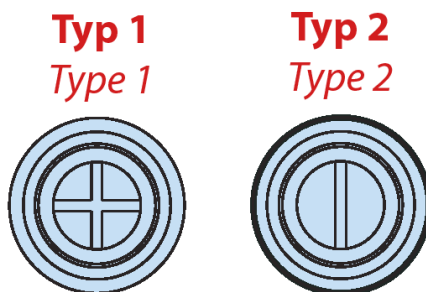
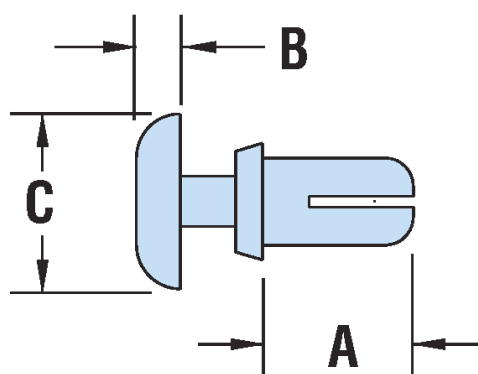

Dane techniczne:

- **Materiał:** Nylon 6 UL94 V-2 lub Nylon 6/6 UL94 V-0
- **Kolor:** biały lub czarny
- **Zakres temperatur:** -40°C do 115°C

Symbol	Średnica otworu montażowego	Zakres grubości panelu	A	B	C	Siła ekstrakcji	Typ	Materiał	Klasa palności	Kolor
	[mm]		[mm]	[mm]	[mm]					
H-9030F	3.1	2.0 - 3.0	4.6	1.5	6.4	7.8	2	PA 66	UL94 V-0	czarny