

## FSR - Stopka zatrzaskowa

**Rys. 1**

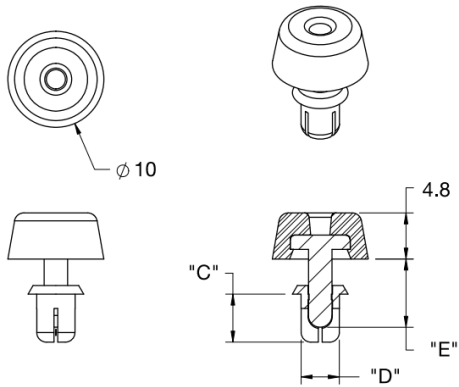

**Rys. 2**

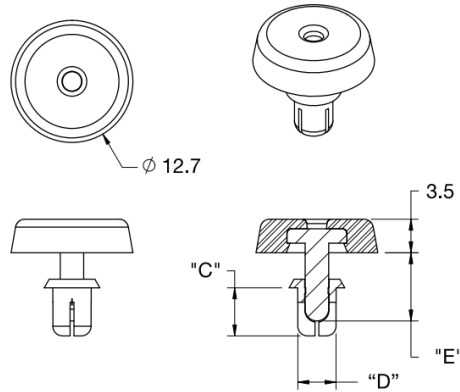

**Otwór montażowy**

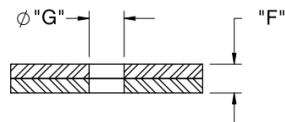

**Dane techniczne:**

- Nit: **UL94 V2 Nylon 6, RMS-52**
- Stopka: **TPE, RMS-351**
- **Kolor:** czarny
- **Minimum zakupu:** 1000 szt.

Symbol	Zakres średnicy otworu montażowego	Zakres grubości panelu	C	D	E	Rys.	Materiał	Kolor
	G	F						
	[mm]	[mm]	[mm]	[mm]	[mm]			
FSR-5	3.6 - 3.7	2.1 - 3	4.5	3.5	6.1	2	TPE	czarny