

FM - Gumowy trzpień montażowy do wentylatorów

Fig. 1

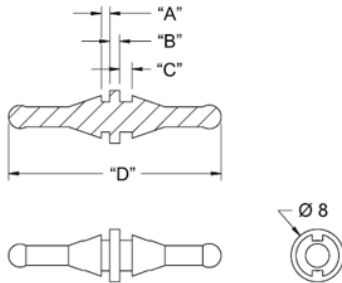

Fig. 2

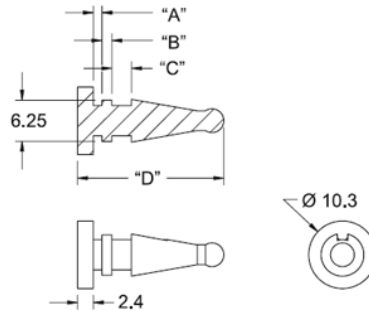

Fig. 3

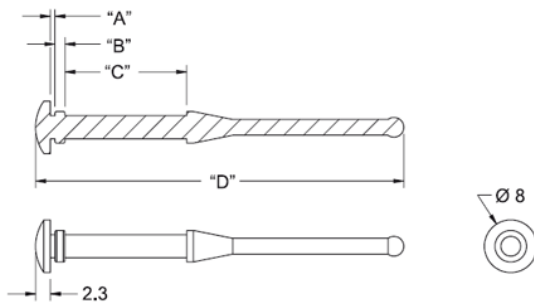
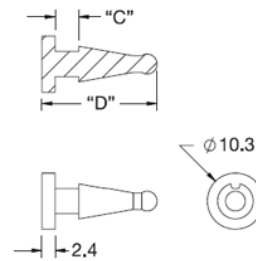

Fig. 4



Dane techniczne:

- **Materiał:** patrz tabela
- **Kolor:** czarny
- Minimum zakupu: 1000 szt.

Symbol	A	B	C	D	Średnica otworu montażowego	Grubość wentylatora	Zakres grubości panelu	Rys.	Materiał	Kolor
	[mm]	[mm]	[mm]	[mm]	[mm]	[mm]	[mm]			
FM-3	1.3	1.5	3	22.2	5	3.1	1.4 maks.	2	EPDM, 30 Shore A	czarny

* - Maksymalna grubość panelu wraz z wentylatorem