

FP-319 - Stopki elastyczne

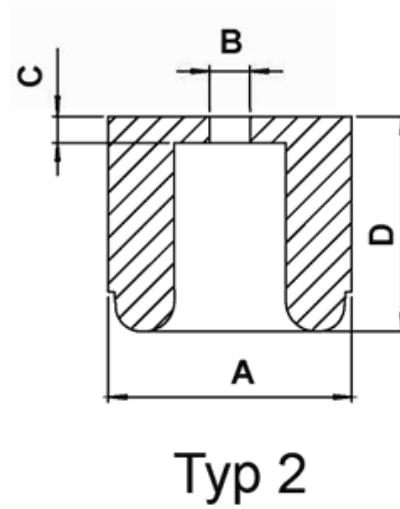
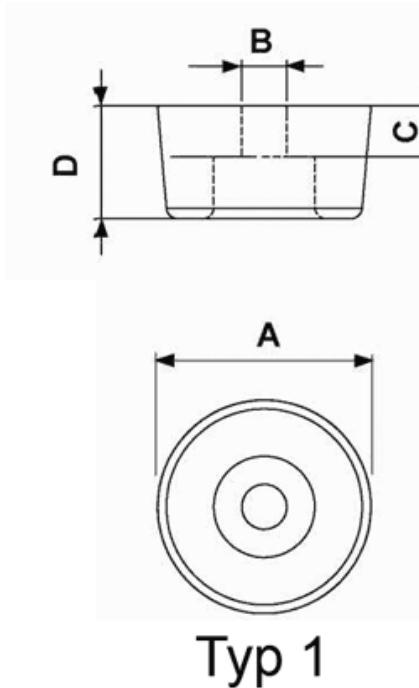

Dane techniczne:

- **Materiał: miękki PCW lub polietylen niskiej gęstości (LDPE)**
- **Kolor: czarny**

Symbol	Typ	Średnica zewn. A	B	C	Wysokość D	Materiał	Kolor	Opakowanie
		[mm]	[mm]	[mm]	[mm]			[szt./pcs]
4707EA01	2	24	6	6	21	LDPE	czarny	1000