

FP-2882 - Podkładki pod śruby

TYP 1

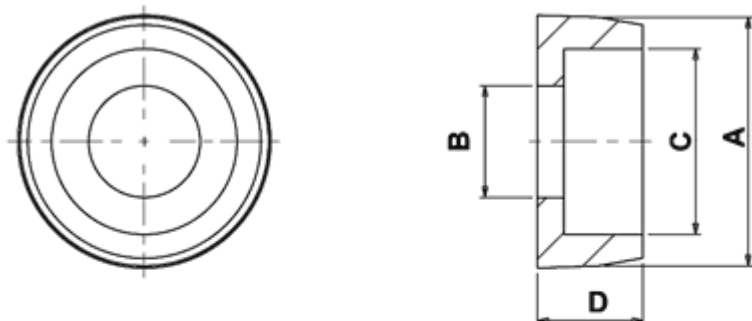

TYP 2

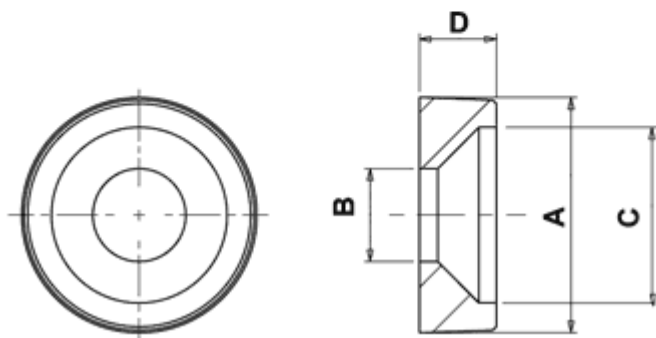

Dane techniczne:

- **Materiał: PA 6.6**
- **Klasa palności: UL94V2**
- **Kolor: czarny**
- Temperatura pracy: -35°C do +85°C

Symbol	Typ	Średnica zewn. A	Średnica wewn. B	C	Wysokość D	Materiał	Klasa palności	Kolor
		[mm]	[mm]	[mm]	[mm]			
2884AA01	1	11.8	5.3	8.8	5	PA 66	UL94 V-2	czarny