

FP-11496 - Podstawki LED

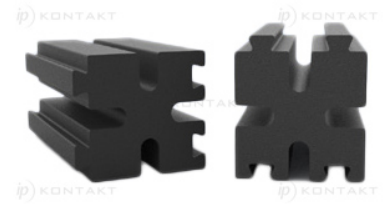
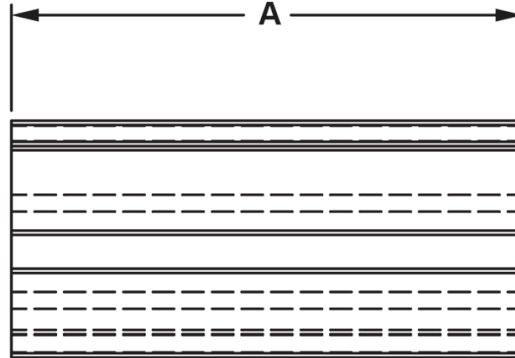
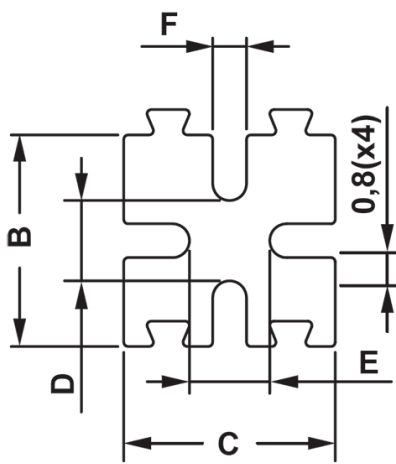

Dane techniczne:

- **Materiał:** PA 6.6
- **Klasa palności:** UL94 V-2
- **Kolor:** czarny
- **Temperatura pracy:** -35°C do 85°C

Symbol	Wysokość A	B	C	D	E	F	Materiał	Klasa palności	Kolor
	[mm]	[mm]	[mm]	[mm]	[mm]	[mm]			
11496AA0118.0	18	5	5	1.9	1.9	0.8	PA 66	UL94 V-2	czarny