

**FP-11496 - Podstawki LED**

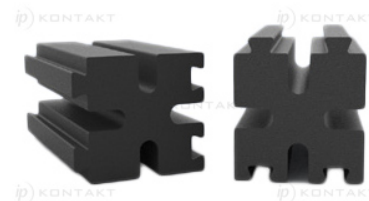
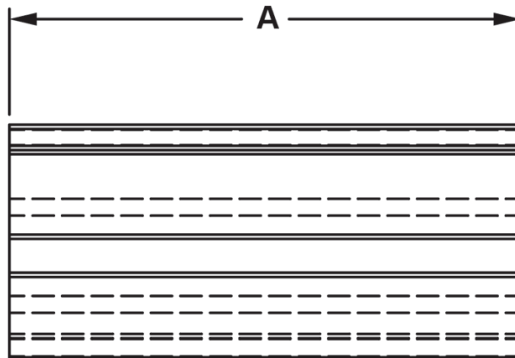
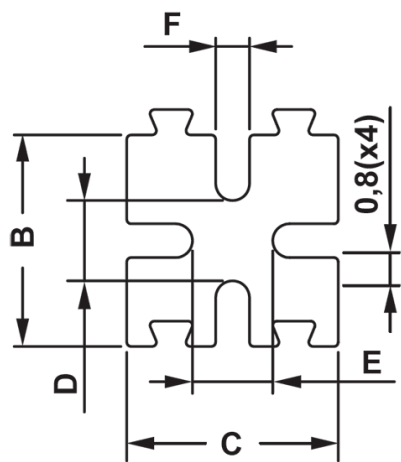

Dane techniczne:

- **Materiał: PA 6.6**
- **Klasa palności: UL94 V-2**
- **Kolor: czarny**
- Temperatura pracy: -35°C do 85°C

Symbol	Wysokość A	B	C	D	E	F	Materiał	Klasa palności	Kolor
	[mm]	[mm]	[mm]	[mm]	[mm]	[mm]			
11496AA0104.0	4	5	5	1.9	1.9	0.8	PA 66	UL94 V-2	czarny