

FP-10403 - Plastikowe nakrętki radełkowe

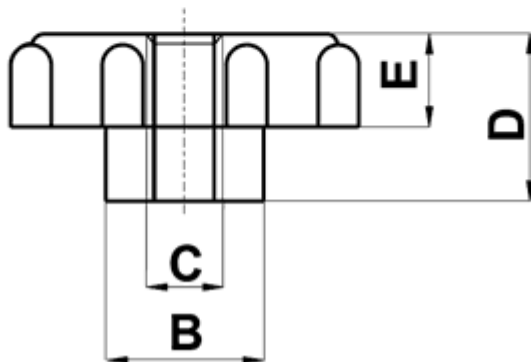
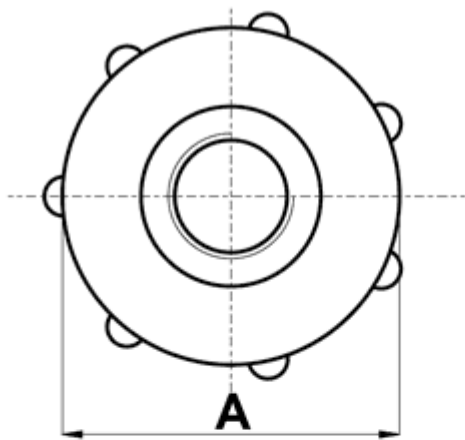

Dane techniczne:

- **Materiał: PA 6**
- **Kolor: naturalny**
- Temperatura pracy: -30°C do +100°C
- Opakowanie: 1000 szt.

Symbol	A	B	Gwint C	Wysokość D	E	Materiał	Kolor	Uwagi
	[mm]	[mm]		[mm]	[mm]			
10405AA00	16	10	M6	6	4.5	PA 6	naturalny	DIN 467