

FP-319 - Stopki elastyczne

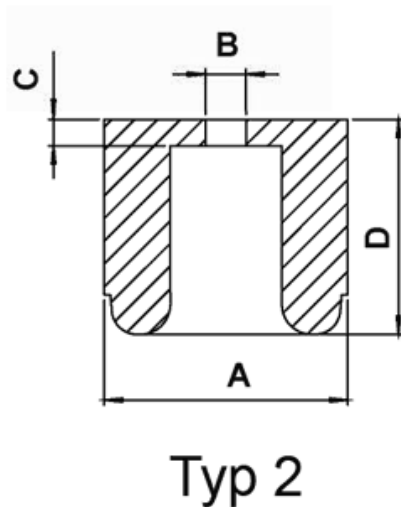
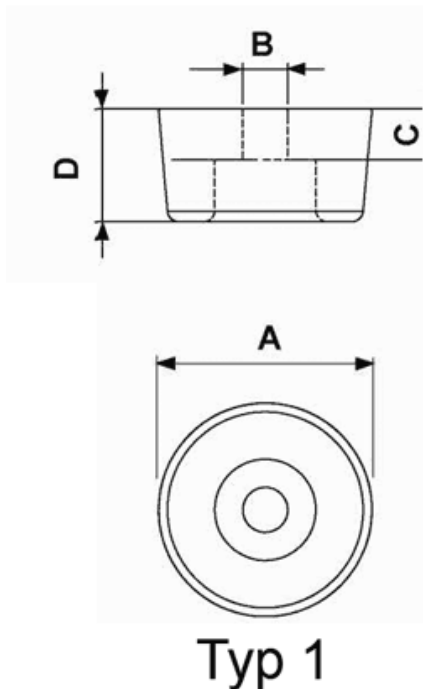

Dane techniczne:

- **Materiał:** miękki PCW lub polietylen niskiej gęstości (LDPE)
- **Kolor:** czarny

Symbol	Typ	Średnica zewn. A	B	C	Wysokość D	Materiał	Kolor	Opakowanie
		[mm]	[mm]	[mm]	[mm]			[szt./pcs]
1015CA01	1	19	3.5	7	13	Miękkie PVC	czarny	2500