

FP-10076 - Okrągłe tulejki dystansowe

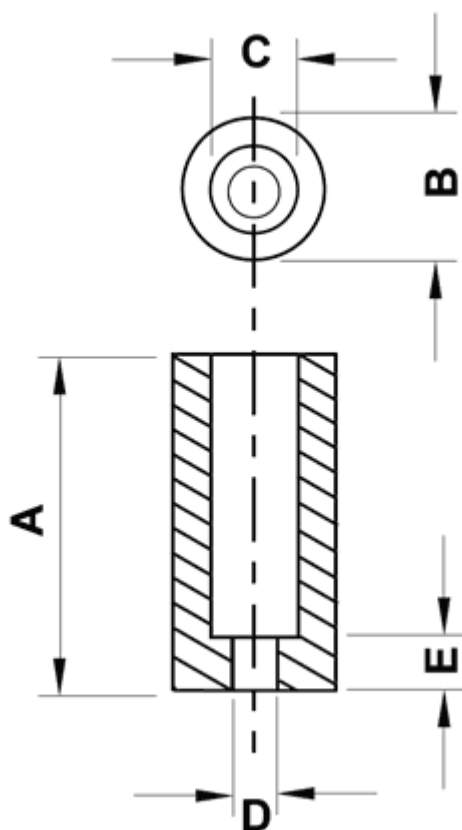

Dane techniczne:

- **Material:** Nylon 6.6 25% GF
- **Kolor:** czarny
- Klasa palności: UL94HB
- Temperatura pracy: -35°C do +110°C

Symbol	Wysokość A	Średnica zewn. B	Średnica wewn. C	D	E	Materiał	Klasa palności	Kolor
	[mm]	[mm]	[mm]	[mm]	[mm]			
10078BB0134.0	34	7	4.5	3.7	2	PA+GF	UL94 HB	czarny