

FP-0426 - Nóżki wciskane

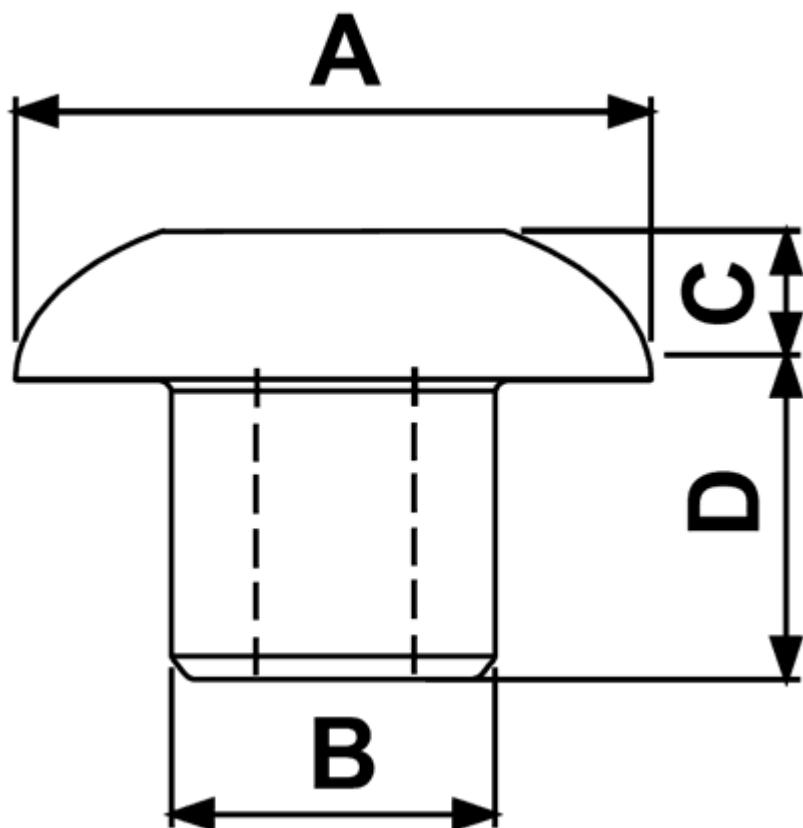

Dane techniczne:

- **Materiał: Miękkie PVC lub LDPE**
- **Kolor: czarny**
- Temperatura pracy (PVC): -25°C do +60°C
- Temperatura pracy (LDPE): -30°C do +60°C
- Opakowanie: 2500 szt.

Symbol	Średnica zewn. ØA	ØB	C	D	Materiał	Kolor
	[mm]	[mm]	[mm]	[mm]		
0966CA01	10	8	3	9	Miękkie PVC	czarny