

WIT-DH - Double-Loop Tie

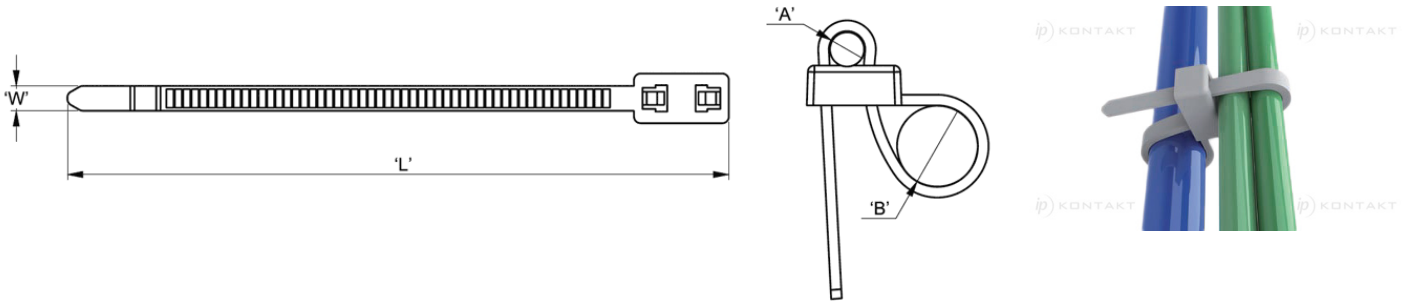

Details:

- **Material:** UL94 V-2 Nylon 6/6, RMS-01*
- **Color:** natural, black
- **Standard Pack:** 100/Bag

Symbol	Tensile strength	Width W	Length L	A max.	B max.	Material	Flammability	Color
	[daN]	[mm]	[mm]	[mm]	[mm]			
WIT-DH-2BK	22.2	4.8	300	72	70	PA 66	UL94 V-2	black