

WIT-30RCA - Cupped Cable Ties

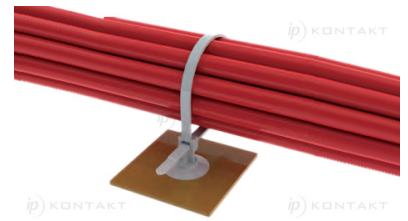
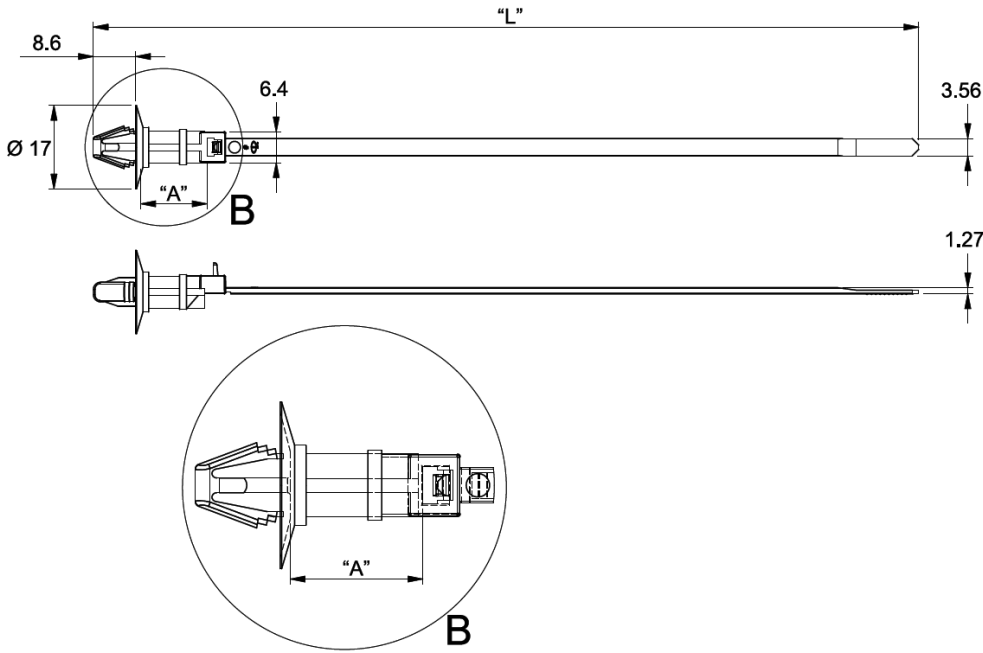

Details:

- **Material:** UL94 V-2, Nylon 6/6, RMS-01*
- **Material:** UL94 V-2, UV Stabilized Nylon 6/6, RMS-46*
- **Material:** UL94 V-2, Heat Stabilized Nylon 6/6, RMS-47*
- **Material:** UL94 V-0, Nylon 6/6, RMS-19*
- **Color:** see table
- **Standard Pack:** 1000/Bag

Symbol	Tensile strength	Length L	Max. cable bundle diameter	A	Mounting hole diameter range	Panel thickness range	Material	Flammability	Color
	[daN]	[mm]	[mm]	[mm]	[mm]	[mm]			
WIT-30RCA-4UVB	13	160.7	31.8	7.1	6.0 - 6.5	0.6 - 2.5	PA 66 UV stabilized	UL94 V-2	black