

TNSP-I/I - Metric Low Voltage Insulators

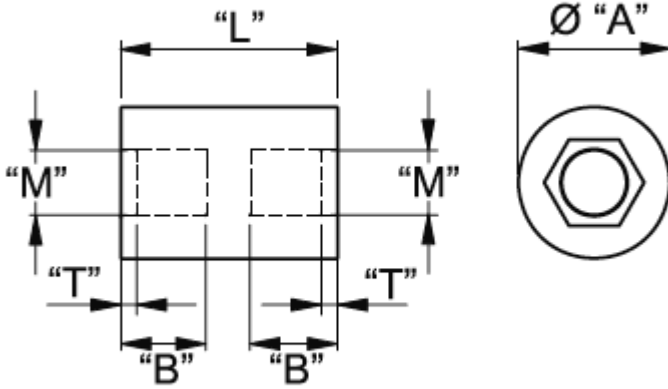

Details:

- **Body material: polyamide 66**
- **Threads material: brass**
- **Color: natural**

Symbol	Int. thread M	Length L	Diameter A	Int. thread length B	T	Material
		[mm]	[mm]	[mm]	[mm]	
TNSP-M8-19.0-97-I/I	M8	97	19	14	1.88	PA 66, brass