

**TNSP-I/I - Metric Low Voltage Insulators**

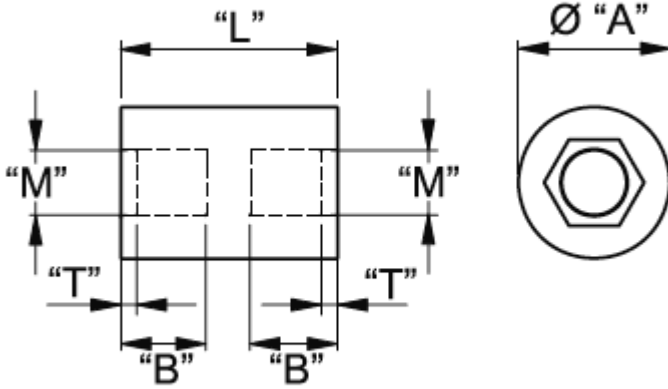

Details:

- **Body material: polyamide 66**
- **Threads material: brass**
- **Color: natural**

Symbol	Int. thread M	Length L	Diameter A	Int. thread length B	T	Material
		[mm]	[mm]	[mm]	[mm]	
TNSP-M8-15.9-33-I/I	M8	33	15.9	14	1.88	PA 66, brass