

**TNSP-I/I - Metric Low Voltage Insulators**

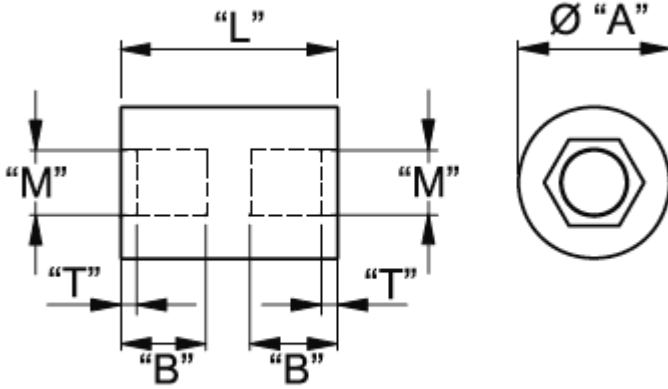

Details:

- **Body material: polyamide 66**
- **Threads material: brass**
- **Color: natural**

Symbol	Int. thread M	Length L	Diameter A	Int. thread length B	T	Material
		[mm]	[mm]	[mm]	[mm]	
TNSP-M2.5-6.5-78-I/I	M2.5	78	6.5	6	0.68	PA 66, brass