

## SVF - Shock & Vibration Dampening Foot

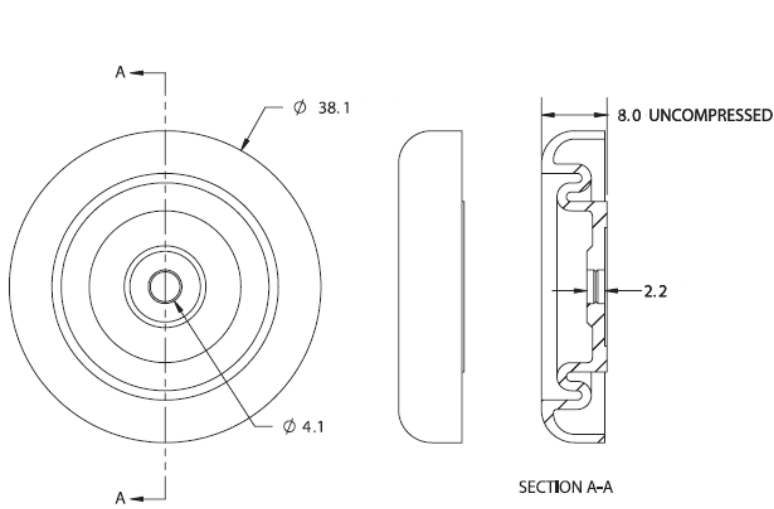

**Details:**

- **Material: TPE**
- **Color: black**
- Standard pack: 1000/Bag

Symbol	Panel thickness range	Used with snap rivet	Material	Shore A hardness	Color
	[mm]				
SVF-2 3.3	2.3 - 3.3	SR - 4070	TPE	64	black