

SVF - Shock & Vibration Dampening Foot

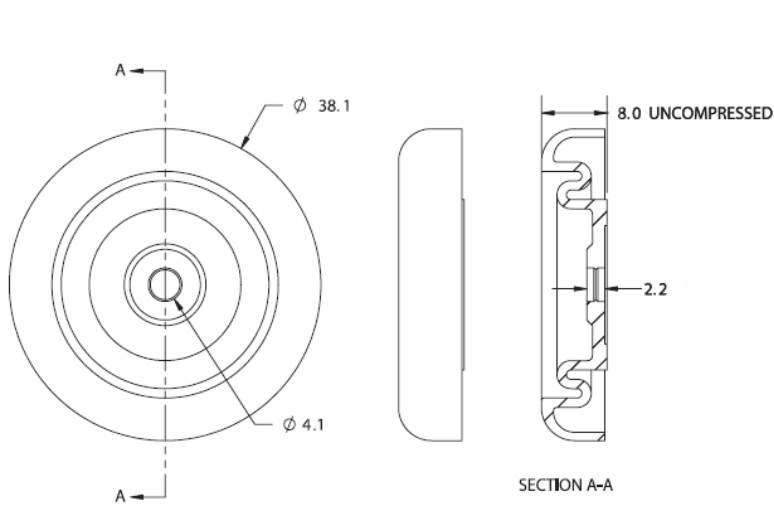

Details:

- **Material: TPE**
- **Color: black**
- Standard pack: 1000/Bag

Symbol	Panel thickness range	Used with snap rivet	Material	Shore A hardness	Color
	[mm]				
SVF-2 2.3	1.3 - 2.3	SR - 4060	TPE	64	black