

SRLCBS - Snap Rivet Locking Circuit Board Support

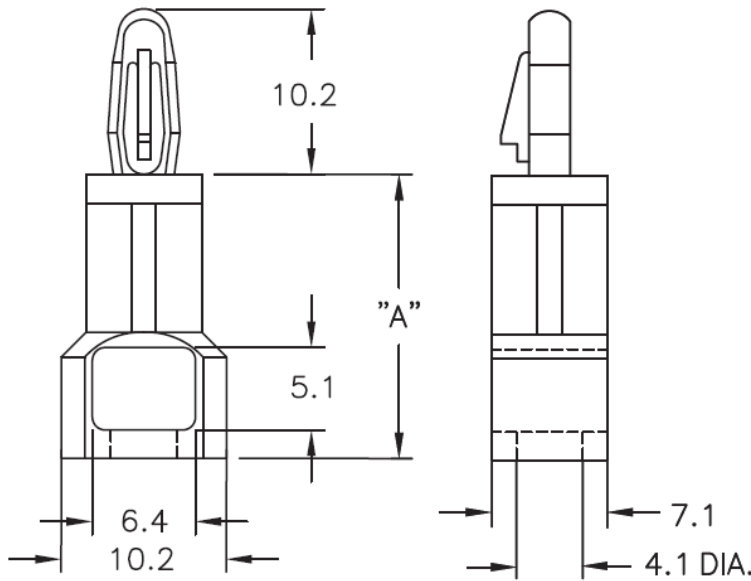

Details:

- **Material: Nylon 6/6, RMS-01***
- **Color: Natural**
- **Standard pack: 1000 pcs**

Symbol	Height A	Top mounting hole dia. ±0.08	Top panel thickness	Bottom mounting hole dia. +0.1	Material	Flammability	Color
	[mm]	[mm]	[mm]	[mm]			
SRLCBS-7-01	11.1	4	1.57	4.1	PA 66	UL94 V-2	natural

Rivet Part No.		For panel thickness
		[mm]
SR-4050	SRVO-4050	0.7-1.6
SR-4060	SRVO-4060	1.5-2.7
SR-4070	SRVO-4070	2.7-3.7
SR-4080	SRVO-4080	3.7-4.7
SR-4090	SRVO-4090	4.7-5.7
SR-4100	SRVO-4100	5.7-6.7
SR-4120	SRVO-4120	7.2-8.7