

SRHR - Snap Rivet Heat Resistant

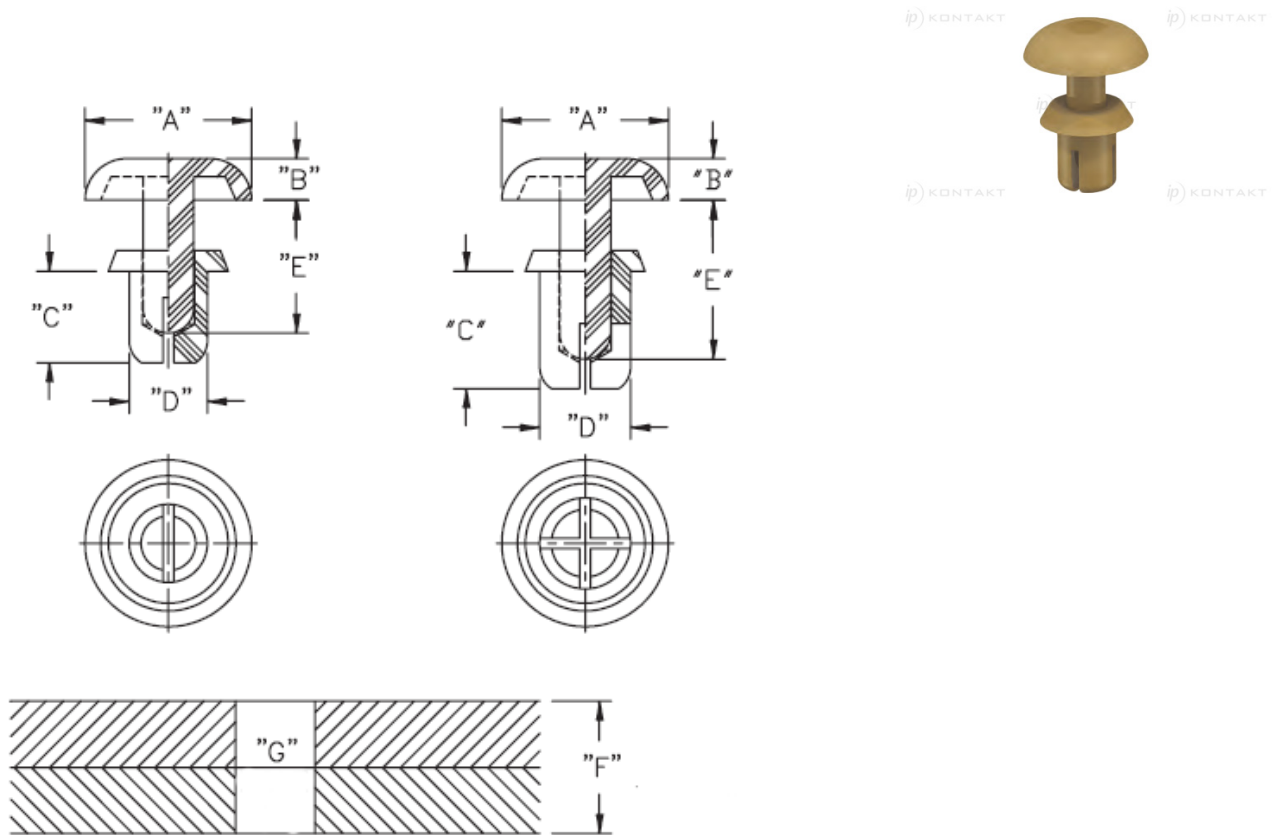

Details:

- **Material: UL94 V2 Nylon 4/6, RMS-109***
- **Color: Tan**
- Working temperature upto: +152°C
- Standard Pack: 1000/Bag

Symbol	Mounting hole diameter range G	Panel thickness range F	A ±0.2	B ±0.2	C ±0.3	D	E ±0.3	Material	Flammability	Color
	[mm]	[mm]	[mm]	[mm]	[mm]	[mm]	[mm]			
SRHR-3555	3.6 - 3.7	3.0 - 4.0	6.4	1.6	5.6	3.5	7.1	PA 46	UL94 V-2	brown