

## SR - Snap Rivets

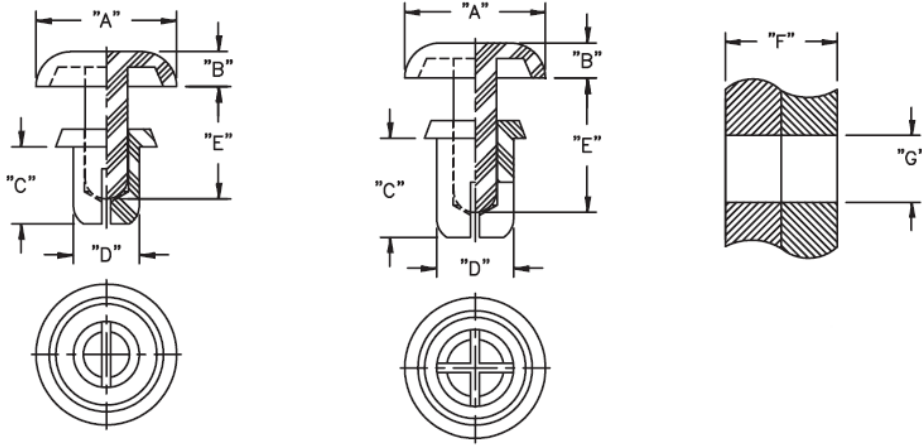

**Details:**

- **SR Material: UL94 V2 Nylon 6**
- **SRVO Material: UL94 V0 Nylon 6/66**
- **Standard Pack: 1000/Bag**

Symbol	Mounting hole diameter range G	Max. load	Panel thickness range F	A	B	C	D	E	Rys. / Fig.	Material	Flammability	Color
	[mm]			[kg]	[mm]	[mm]	[mm]	[mm]				
SR-3055B	3.1 - 3.2	8	3 - 4	6.4	1.6	5.6	3	6.1	1	PA 66	UL94 V-2	black