

SFCBS - Stud Fitting Circuit Board Support

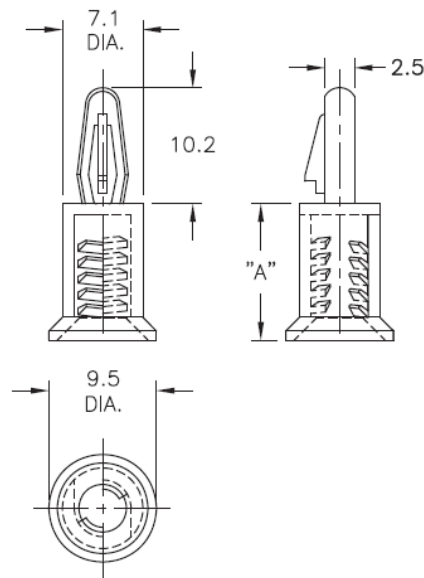

Details:

- **Material: Nylon 6/6, UL 94 V-2, RMS-01***
- **Material: Nylon 6/6, UL 94 V-0, RMS-19***
- **Color: natural**
- **Standard pack: 1000 pcs**

Symbol	Height A ±0.4	Top mounting hole dia. ±0.08	Top panel thickness	Int. thread	Int. thread length	Material	Flammability	Color
	[mm]	[mm]	[mm]		[mm]			
SFCBS-M4-14M-19	14	4	1.57	M4	12	PA 66	UL94 V-0	natural