

## RLEHCBS - Reverse Locking Edge Holding Circuit Board Support

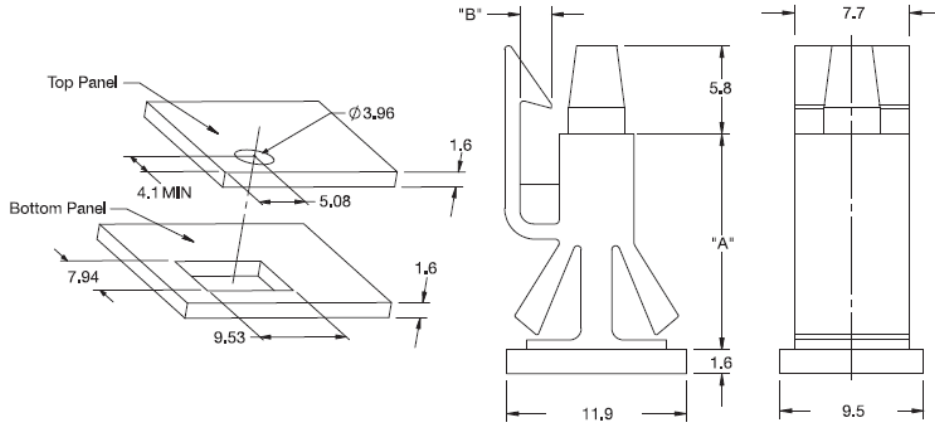

**Details:**

- **Material: Nylon 6/6, UL 94 V-2, RMS-01\***
- **Material: Nylon 6/6, UL 94 V-0, RMS-19\***
- **Color: black**
- **Standard pack: 1000 pcs**

Symbol	Height A ±0.4	B	Top mounting hole dia.	Top panel thickness	Bottom panel thickness	Material	Flammability	Color
	[mm]							
RLEHCBS-7-01BK	12.7	2.1	3.96	1.6	1.6	PA 66	UL94 V-2	black