

RFP - Ribbon Cable Split Cores

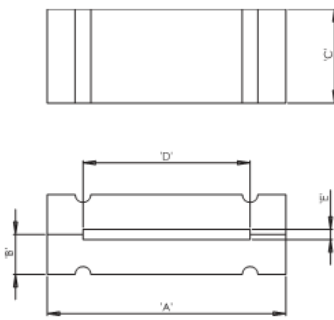

Rys. 1

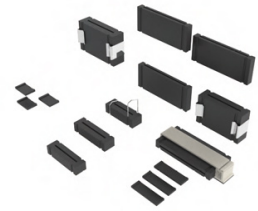
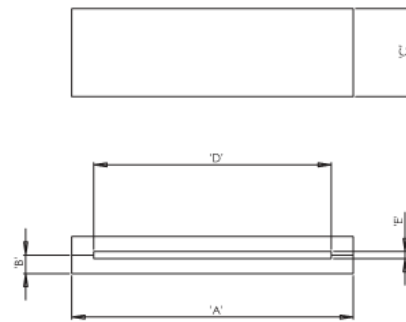

Rys. 2

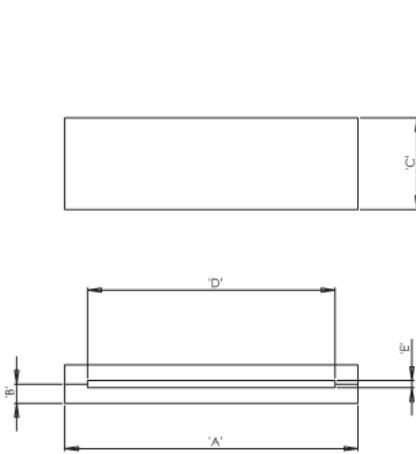

Rys. 3

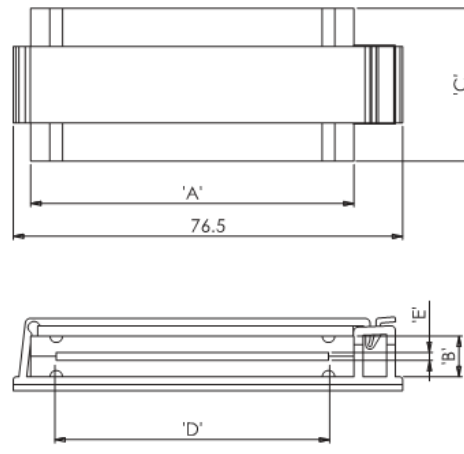

Rys. 4
samoprzylepny spód

Details:

- Ferrite Material: A5 RMS-303*
- Casing Material: Nylon 6/6. RMS-244*
- Metal Clamp & Spring: RMS-305

Symbol	Fig.	Mounting	A	B	C	D	E	Impedance @25MHz	Impedance @100MHz	Standard pack
			[mm]	[mm]	[mm]	[mm]	[mm]	[Ω]	[Ω]	[szt./pcs]
RFP2-20-12-A5	2	-	32	2.1	12	27	0.4	30	87	315