

OR-MDLA-PG - Brass cable gland with PG thread, nickel plated

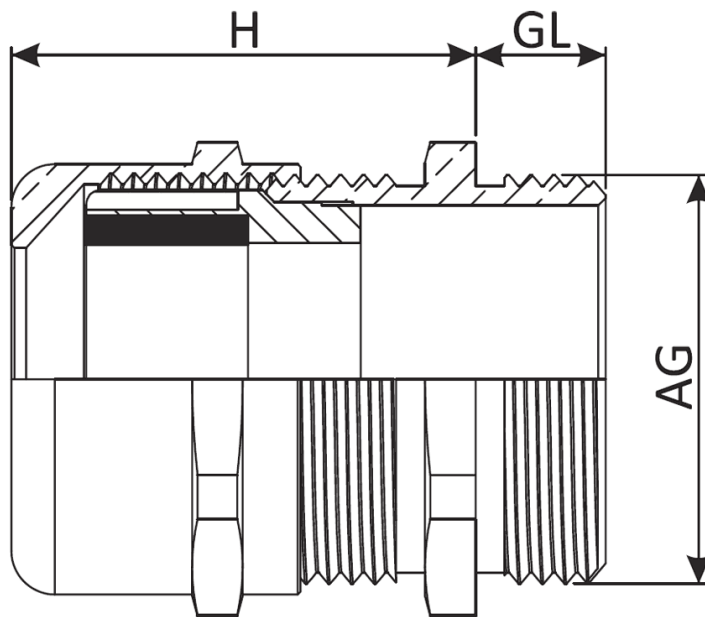

Details:

- Material:
 - Body: brass, nickel plated
 - Clamping insert: PA6 UL94 V-2
 - Sealing ring: TPV
 - O-Ring: NBR
- Thread: PG (DIN 40430)
- Protection class: IP68 (5 bar)
- Temperature range: -40°C to +100°C
- Easy to assemble
- Halogen free

Symbol	PG thread	H	Thread length GL	Wrench size	Cable diameter range	Material
		[mm]	[mm]	[mm]	[mm]	
OR-MDLA-PG9-L	PG9	23	10	17	4 - 8	brass, nickel plated