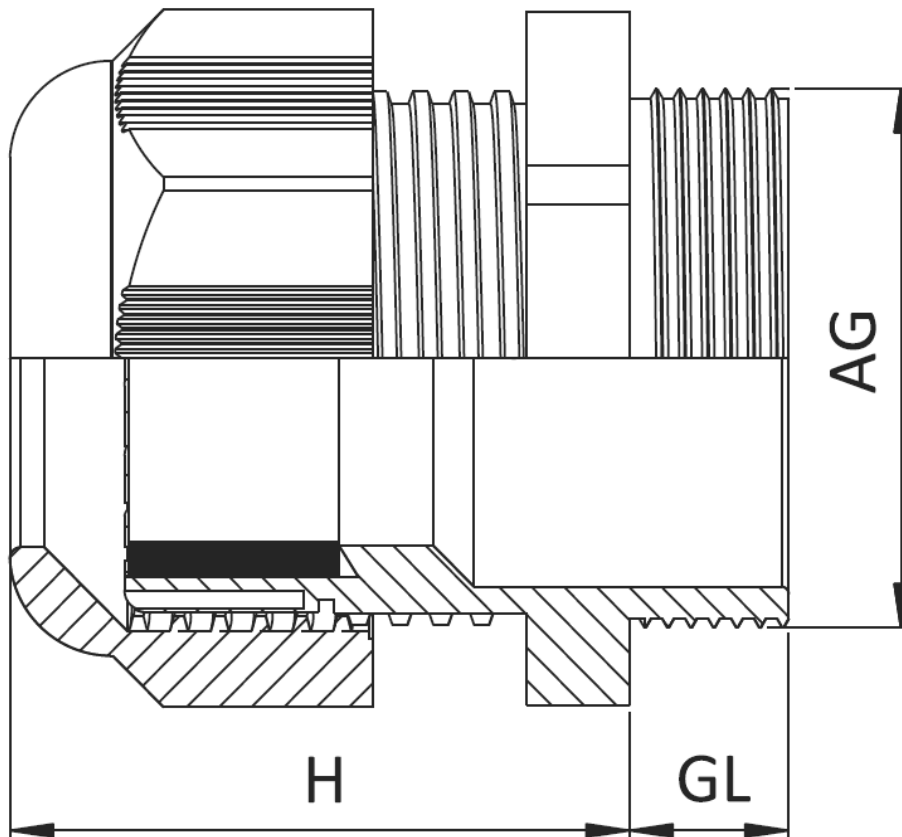

OR-DLA-PG - Nylon cable gland with PG thread**Details:**

- **Body material: PA 6 V2**
- Colour:
 - grey (RAL 7001)
 - light grey (RAL 7035)
 - black (RAL 9005)
- Thread: PG (DIN 40430)
- Protection class: IP 68 5 bar
- Working temperature: -30°C to +80°C (150°C short-term)
- Antivibration protection
- UV resistance
- Halogen free
- Type 1: standard version
- Type 2: long version

Symbol	Type	PG thread AG	H	Thread length GL	Wrench size	Cable diameter range	Material	Flammability	Color
			[mm]	[mm]	[mm]	[mm]			
OR-DLA-PG9-DGR	1	PG9	28	8	19	4 - 8	PA 6	UL94 V-2	dark grey