

O-TUL - Nylon mounting sleeve

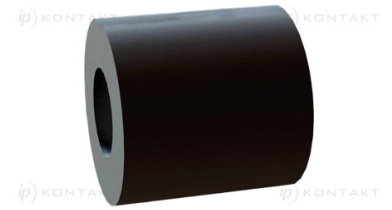
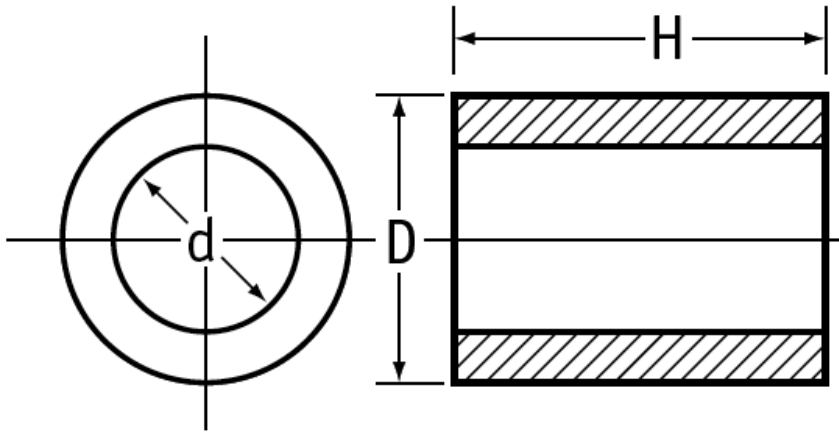

Details:

- **Material: Nylon 6.6, POM (polyoxymethylene), PS (polystyrene)**
- **Color: natural, black**
- **Minimum order qty: 100 pcs**

Symbol	Int. diameter d	Ext. diameter D	Height H	Material	Color
	[mm]	[mm]	[mm]		
O-TUL-26-40-30-P-NAT	2.6	4	3	POM	natural