

O-SLS - Slotted Countersunk Screws

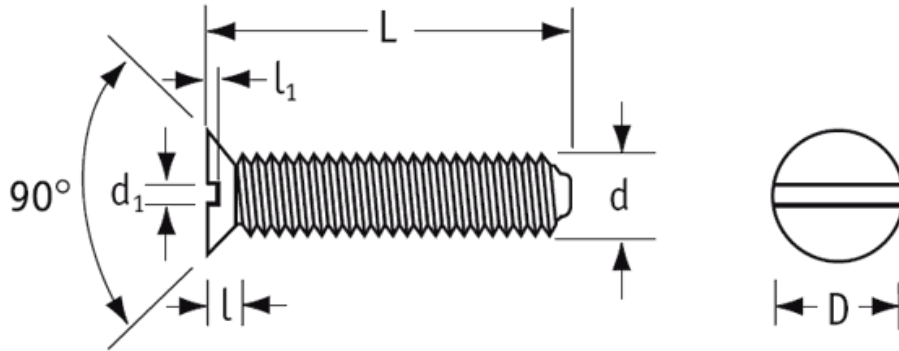

Details:

- **Material: Nylon 6.6**
- **Color: see table**
- Refer to standard ISO 2009, NF E 25-123, DIN 963 for guidance purposes only
- O-SLS-M5-100-NAT niezgodny z normą DIN 963

Symbol	Thread d	L	Head diameter D	Head height l	d ₁	l ₁	Material	Color	Standard pack
		[mm]	[mm]	[mm]	[mm]	[mm]			[szt./pcs]
O-SLS-M3-160-NAT	M3	16	6	1.7	0.8	0.9	PA 66	natural	1000