

O-POKP - Thumb screw

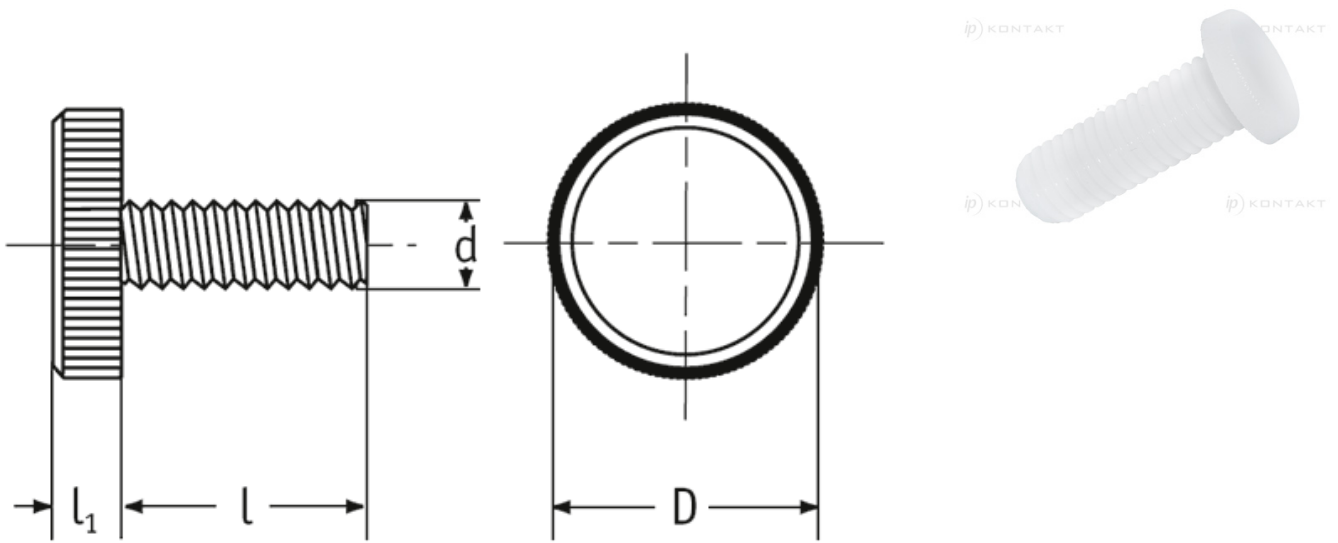

Details:

- **Material: Nylon 6.6**
- **Color: natiral (NAT), black (BLK)**
- Standard pack: see table

Symbol	Thread d	Head diameter D	Thread length l	Head height l ₁	Material	Color	Standard pack
		[mm]	[mm]	[mm]			[szt./pcs]
O-POKP-M8-160-160-NAT	M8	16	16	3.4	PA 66	natural	1000