

O-OKPVC2 - PVC Edge Protector

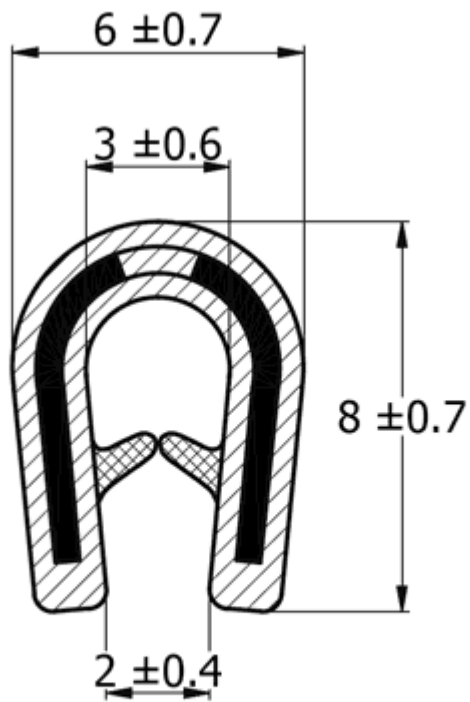

Typ 1

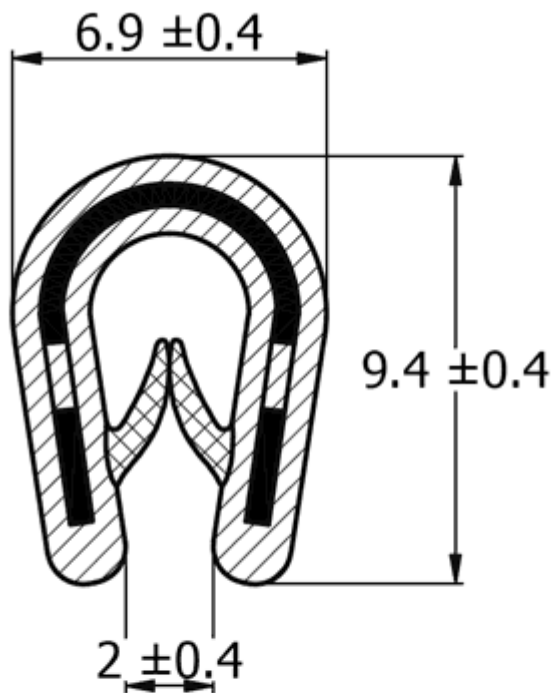

Typ 2





Typ 3



Typ 4



Typ 5



Typ 6



Typ 7



Typ 8



Typ 9

Details:

- **Material: PVC with steel spring core**
- **Color: Black (BLK), gray (GR), white (WH)**
- Supplied in rolls of 20m
- Provided protection to steel edges
- Profiles are flexible and pressed on by hand
- Suitable for -40°C to +90°C

Symbol	Type	Panel thickness range	Material	Color	Standard pack
		[mm]			[m]
O-OKPVC2-09-WH	9	1 - 2	PVC	white	20