

O-ACLP - Assembly clips

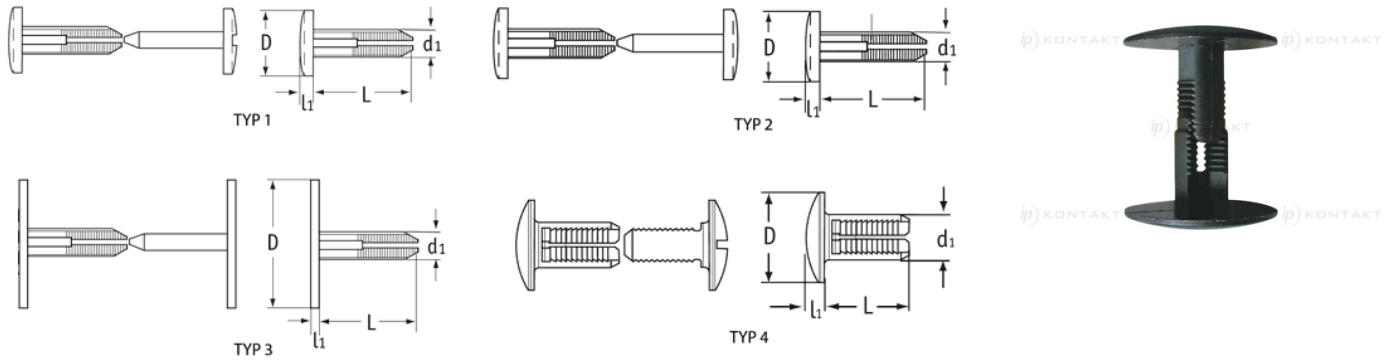

Details:

- **Material: Nylon 6.6**
- **Colour: black or white**
- Standard pack: 1000 pcs
- Type 1: 12mm Head with slot
- Type 2: 12mm Head without slot
- Type 3: 19mm Head without slot
- Type 4: 20mm Rounded Head with slot

Symbol	Mounting hole diameter range	Panel thickness range	d ₁	Head diameter ØD	Head height l ₁	L	Type	Material	Color
	[mm]	[mm]	[mm]	[mm]	[mm]	[mm]			
O-ACLP-1-180-05-WH	5 - 8	18.0 - 28.0	5	12	3	18	1	PA 66	white