

MSCBS - Studded Circuit Board Support

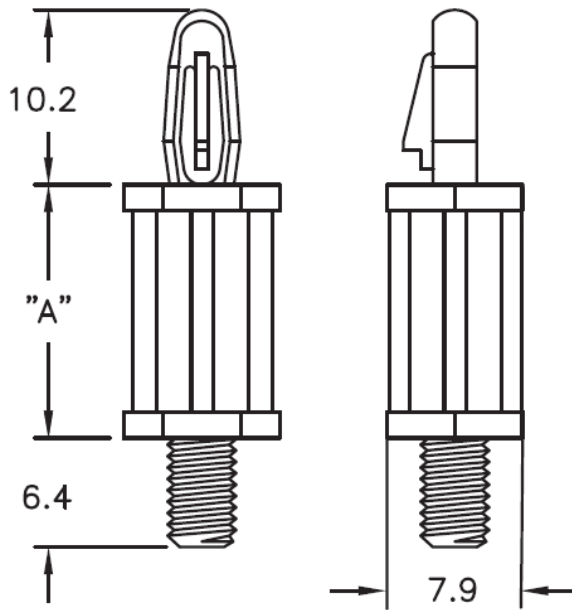

Details:

- **Material:** Nylon 6/6, UL 94 V-2, RMS-01*
- **Material:** Nylon 6/6, UL 94 V-0, RMS-19*
- **Color:** natural
- **Standard pack:** 1000 pcs

Symbol	Height A ±0.4	Ext. thread	Ext. thread length	Top mounting hole dia. ±0.08	Top panel thickness	Material	Flammability	Color
	[mm]			[mm]				
MSCBS-14-19	22.2	M4	6.4	4	1.57	PA 66	UL94 V-0	natural