

MNI - Molded Nylon Insulator

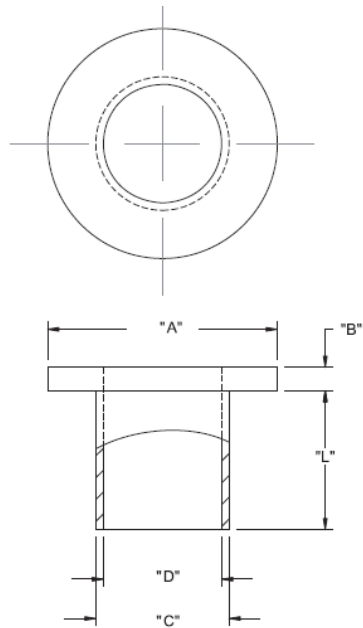

Details:

- **Material: Nylon 6/6, UL 94 V-2, RMS-01***
- **Material: Nylon 6/6, UL 94 V-0, RMS-19***
- **Color: natural**
- **Standard pack: 1000 pcs**

Symbol	Thread	A ±0.18	B ±0.18	C ±0.13	D ±0.13	Length L ±0.13	RMS	Material
		[mm]	[mm]	[mm]	[mm]	[mm]		
MNI#8-2	M4	8.7	1.6	5.2	4.4	0.8	RMS-48	PA 66