

## MNI - Molded Nylon Insulator

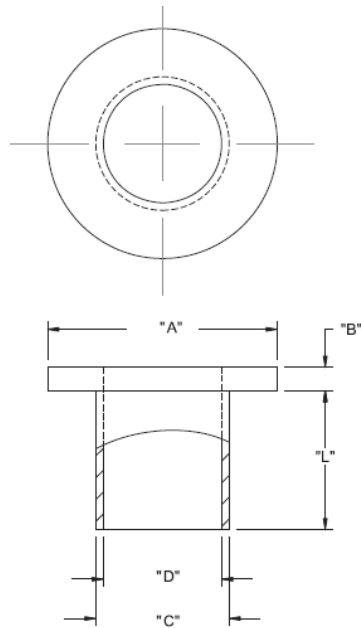

**Details:**

- **Material: Nylon 6/6, UL 94 V-2, RMS-01\***
- **Material: Nylon 6/6, UL 94 V-0, RMS-19\***
- **Color: natural**
- **Standard pack: 1000 pcs**

Symbol	Thread	A ±0.18	B ±0.18	C ±0.13	D ±0.13	Length L ±0.13	RMS	Material
		[mm]	[mm]	[mm]	[mm]	[mm]		
MNI#6-8	M3	7.4	1.2	4.3	3.6	3.2	RMS-48	PA 66