

## ML - Magnetic Latch

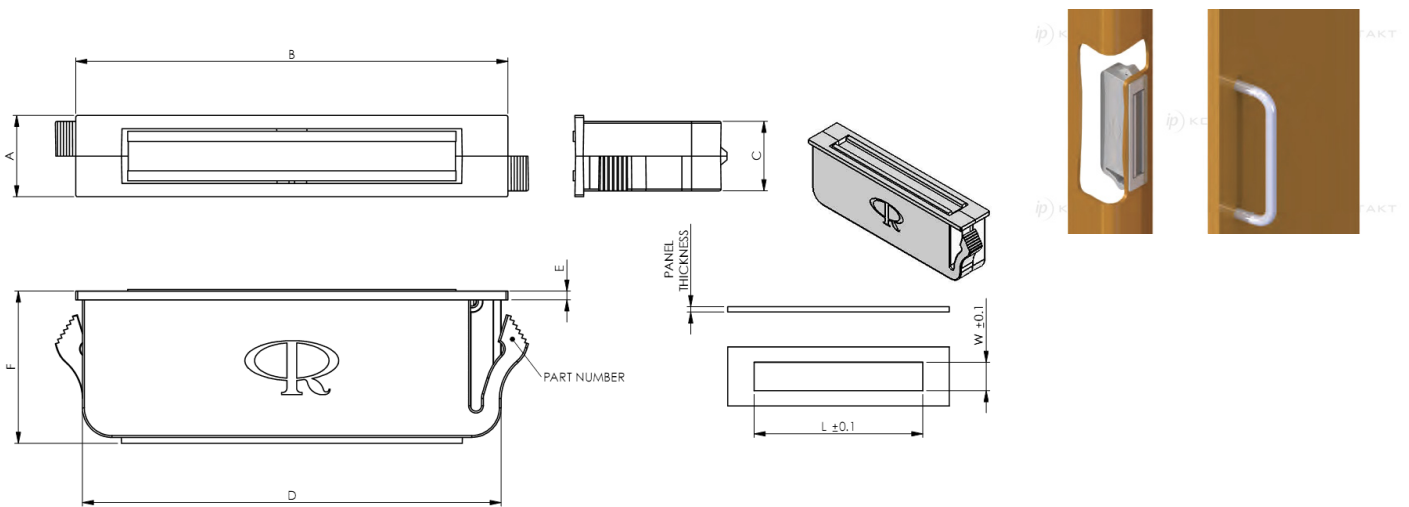

**Details:**

- **Material: Polypropylene, RMS-150\***
- **Color: white, black**
- **Standard Pack: 10/bag**

Symbol	A	B	C	D	E	F	G	H	Panel thickness range	L	W	Color
	[mm]	[mm]	[mm]	[mm]	[mm]	[mm]	[mm]	[mm]	[mm]	[mm]	[mm]	
ML-L-3	11	58.5	9.2	56.7	1.2	64	3.5	20.6	3.5 - 5.0	57.1	9.6	white