

MCCGF - Metal Continuous Cushioned Grommet

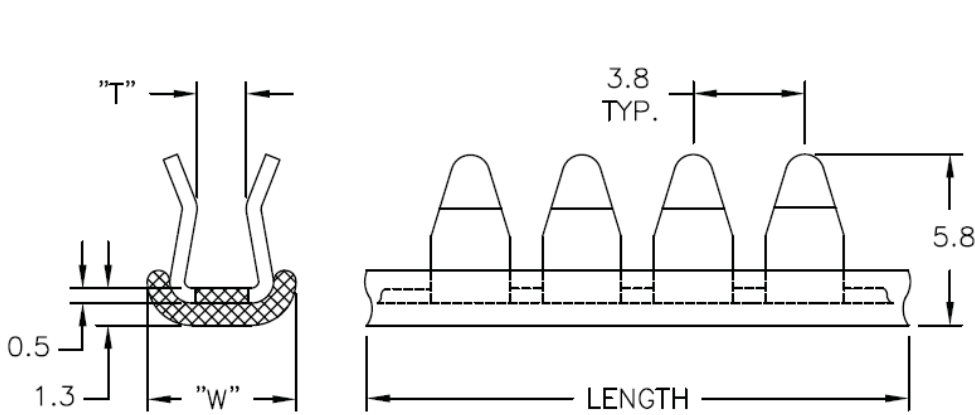

Details:

- Material: 304 Stainless Steel, RMS-283*
- Coating: Nylon 11, RMS-192*
- Cushion: TPE, 60 Shore D, RMS-300*
- Color: Black
- Standard Pack: 30m reel

Symbol	Panel thickness range	W	Standard pack	Material	Flammability	Color
	[mm]	[mm]	[m]			
MCCGF-3N	1.4 - 1.7	4.8	30.5	stainless steel 304	UL94 V-0	black