

## MCCG - Metal Continuous Cushioned Grommet

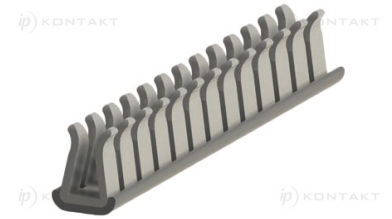
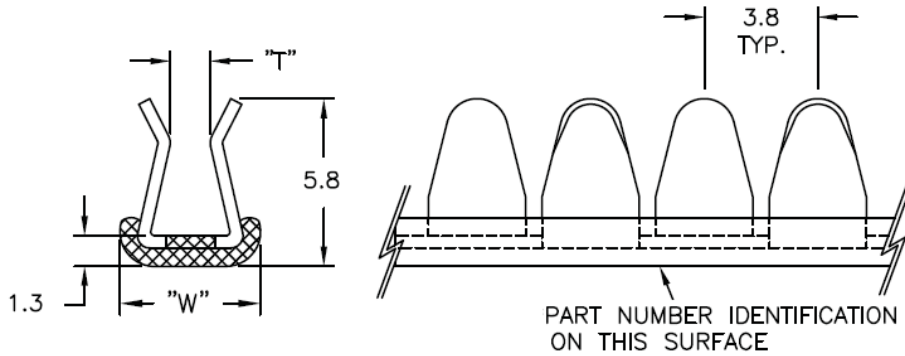

Details:

- **Material: 304 Stainless Steel, RMS-283\***
- **Coating: Nylon 11, RMS-192\***
- **Cushion: TPE, 60 Shore D, RMS-300\***
- **Color: Black**
- **Standard pack: 30m reel**

Symbol	Panel thickness range	W	Standard pack	Material	Flammability	Color
	[mm]	[mm]	[m]			
MCCG-2N	1.1 - 1.4	4.8	30.5	stainless steel 304	UL94 V-0	black