

LCBS-TM - Circuit Board Support

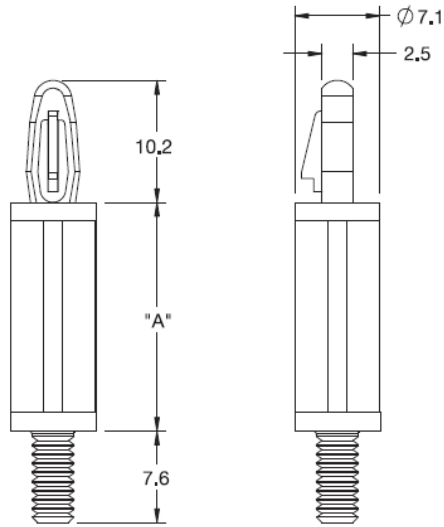

Details:

- **Material: Nylon 6/6, UL 94 V-2, RMS-01***
- **Material: Nylon 6/6, UL 94 V-0, RMS-19***
- **Color: natural**
- **Standard pack: 1000 pcs**

Symbol	Height A ±0.4	Ext. thread	Ext. thread length	Top mounting hole dia. ±0.08	Top panel thickness	Material	Flammability	Color
	[mm]		[mm]	[mm]	[mm]			
LCBS-TM-M4-6-19	9.5	M4	7.6	4	1.57	PA 66	UL94 V-0	natural