

LCBS-9 - Locking Circuit Board Support

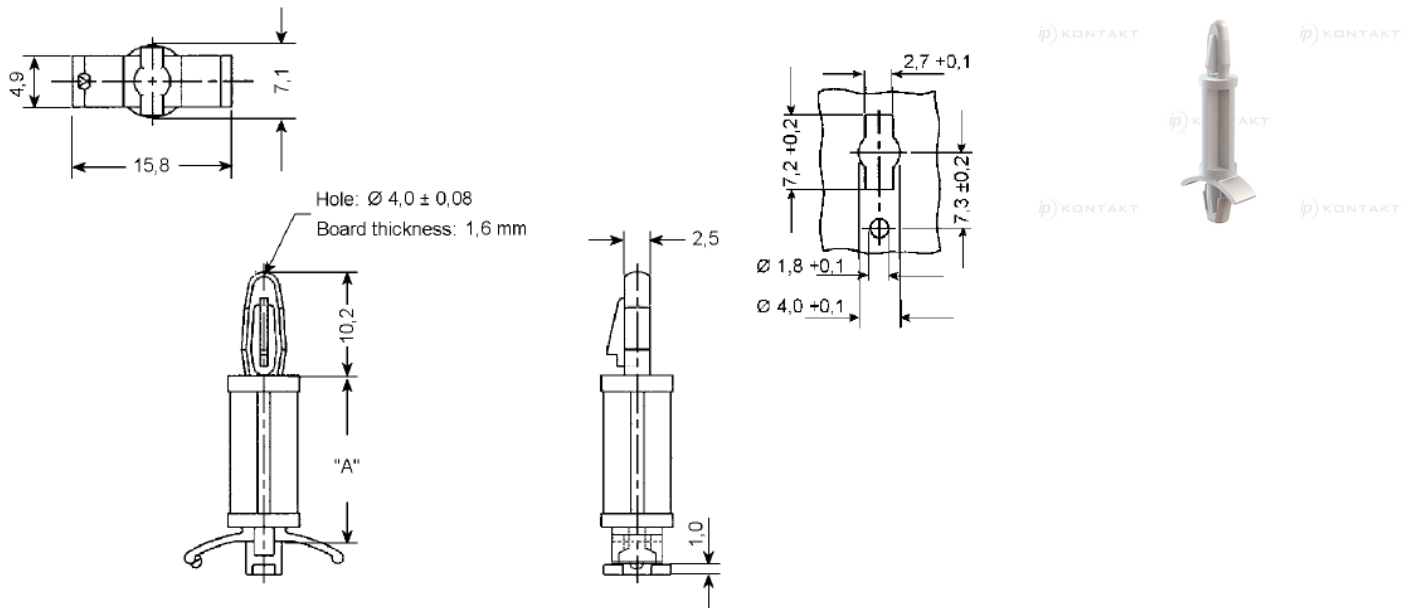

Details:

- **Material:** Nylon 6/6, UL94 V-2, RMS-01* or Nylon 6/6, UL94 V-0, RMS-19*
- **Kolor:** natural
- Standard pack: 1000 pcs

* see specs

Symbol	Height A	Top mounting hole dia. ±0.08	Top panel thickness	Bottom panel thickness range	Material	Flammability	Color
	[mm]	[mm]	[mm]	[mm]			
LCBS-9-5-19	7.9	4	1.6	0.8 - 1.6	PA 66	UL94 V-0	natural